

FEATURES

Filterless stereo Class-D amplifier with Σ - Δ modulation
No sync necessary when using multiple Class-D amplifiers from Analog Devices, Inc.
2 × 2W into 4 Ω load and 2x1.4 W into 8 Ω load at 5.0 V supply with <1% total harmonic distortion (THD + N)
92% efficiency at 5.0 V, 1.4 W into 8 Ω speaker
>103 dB signal-to-noise ratio (SNR)
Single-supply operation from 2.5 V to 5.5 V
20 nA shutdown current; left/right channel control
Short-circuit and thermal protection
Available in a 16-ball, 1.66 mm × 1.66 mm WLCSP
Pop-and-click suppression
Built-in resistors that reduce board component count
User-selectable 6 dB or 18 dB gain setting
User-selectable ultralow EMI emission mode

APPLICATIONS

Mobile phones
MP3 players
Portable gaming
Portable electronics

GENERAL DESCRIPTION

The SSM2356 is a fully integrated, high efficiency, stereo Class-D audio amplifier. It is designed to maximize performance for mobile phone applications. The application circuit requires a minimum of external components and operates from a single 2.5 V to 5.5 V supply. It is capable of delivering 2 × 2W of continuous output power with <1% THD + N driving a 4 Ω load from a 5.0 V supply.

The SSM2356 features a high efficiency, low noise modulation scheme that requires no external LC output filters. The modulation continues to provide high efficiency even at low output power. It operates with 92% efficiency at 1.4 W into 8 Ω or 85% efficiency at 2.0 W into 4 Ω from a 5.0 V supply and has an SNR of >103 dB.

Spread-spectrum pulse density modulation is used to provide lower EMI-radiated emissions compared with other Class-D architectures. The SSM2356 includes an optional modulation select pin (ultralow EMI emission mode) that significantly reduces the radiated emissions at the Class-D outputs, particularly above 100 MHz.

The SSM2356 has a micropower shutdown mode with a typical shutdown current of 20 nA. Shutdown is enabled by applying a logic low to the $\overline{\text{SDNR}}$ and $\overline{\text{SDNL}}$ pins. The device also includes pop-and-click suppression circuitry that minimizes voltage glitches at the output during turn-on and turn-off, reducing audible noise on activation and deactivation.

The fully differential input of the SSM2356 provides excellent rejection of common-mode noise on the input. Input coupling capacitors can be omitted if the dc input common-mode voltage is approximately $V_{\text{DD}}/2$. The preset gain of SSM2356 can be selected between 6 dB and 18 dB with no external components and no change to the input impedance. Gain can be further reduced to a user-defined setting by inserting series external resistors at the inputs.

The SSM2356 is specified over the commercial temperature range (-40°C to $+85^{\circ}\text{C}$). It has built-in thermal shutdown and output short-circuit protection. It is available in a 16-ball, 1.66 mm × 1.66 mm wafer level chip scale package (WLCSP).

FUNCTIONAL BLOCK DIAGRAM

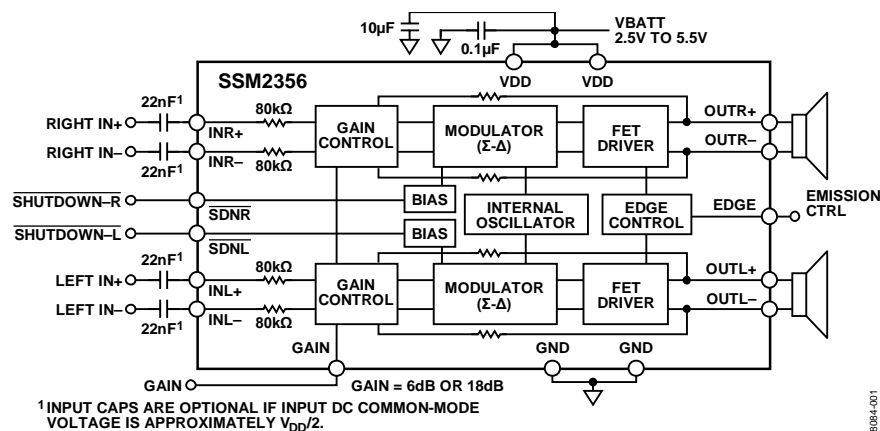

Figure 1.

Rev. A

[Document Feedback](#)

Information furnished by Analog Devices is believed to be accurate and reliable. However, no responsibility is assumed by Analog Devices for its use, nor for any infringements of patents or other rights of third parties that may result from its use. Specifications subject to change without notice. No license is granted by implication or otherwise under any patent or patent rights of Analog Devices. Trademarks and registered trademarks are the property of their respective owners.

One Technology Way, P.O. Box 9106, Norwood, MA 02062-9106, U.S.A.
 Tel: 781.329.4700 ©2009–2013 Analog Devices, Inc. All rights reserved.
[Technical Support](#) www.analog.com

SSM2356* PRODUCT PAGE QUICK LINKS

Last Content Update: 02/23/2017

COMPARABLE PARTS

View a parametric search of comparable parts.

EVALUATION KITS

- SSM2356 Evaluation Board

DOCUMENTATION

Data Sheet

- SSM2356: 2 × 2W Filterless Class-D Stereo Audio Amplifier Data Sheet

User Guides

- UG-193: Evaluation Board for SSM2356 Filterless Class-D Audio Amplifier

DESIGN RESOURCES

- ssm2356 Material Declaration
- PCN-PDN Information
- Quality And Reliability
- Symbols and Footprints

DISCUSSIONS

View all ssm2356 EngineerZone Discussions.

SAMPLE AND BUY

Visit the product page to see pricing options.

TECHNICAL SUPPORT

Submit a technical question or find your regional support number.

DOCUMENT FEEDBACK

Submit feedback for this data sheet.

TABLE OF CONTENTS

| | | | |
|--|----|-------------------------------------|----|
| Features | 1 | Applications Information | 13 |
| Applications..... | 1 | Overview | 13 |
| General Description | 1 | Gain Selection..... | 13 |
| Functional Block Diagram | 1 | Pop-and-Click Suppression | 13 |
| Revision History | 2 | EMI Noise..... | 13 |
| Specifications..... | 3 | Output Modulation Description | 14 |
| Absolute Maximum Ratings..... | 4 | Layout | 14 |
| Thermal Resistance | 4 | Input Capacitor Selection..... | 14 |
| ESD Caution..... | 4 | Proper Power Supply Decoupling..... | 14 |
| Pin Configuration and Function Descriptions..... | 5 | Outline Dimensions | 15 |
| Typical Performance Characteristics | 6 | Ordering Guide | 15 |
| Typical Application Circuits..... | 12 | | |

REVISION HISTORY

3/13—Rev. 0 to Rev. A

| | |
|---|----|
| Changes to Figure 34 and Figure 35, Captions..... | 12 |
| Changes to Gain Selection Section..... | 13 |
| Updated Outline Dimensions | 15 |
| Changes to Ordering Guide | 15 |

5/09—Revision 0: Initial Version

SPECIFICATIONS

$V_{DD} = 5.0\text{ V}$, $T_A = 25^\circ\text{C}$, $R_L = 8\ \Omega + 33\ \mu\text{H}$, EDGE = GND, Gain = 6 dB, unless otherwise noted.

Table 1.

| Parameter | Symbol | Conditions | Min | Typ | Max | Unit |
|------------------------------------|---------------------|---|-----|------------------|--------------|------------------|
| DEVICE CHARACTERISTICS | | | | | | |
| Output Power/Channel | P_O | $R_L = 8\ \Omega$, THD = 1%, $f = 1\ \text{kHz}$, 20 kHz BW, $V_{DD} = 5.0\text{ V}$ | | 1.42 | | W |
| | | $R_L = 8\ \Omega$, THD = 1%, $f = 1\ \text{kHz}$, 20 kHz BW, $V_{DD} = 3.6\text{ V}$ | | 0.75 | | W |
| | | $R_L = 8\ \Omega$, THD = 10%, $f = 1\ \text{kHz}$, 20 kHz BW, $V_{DD} = 5.0\text{ V}$ | | 1.8 | | W |
| | | $R_L = 8\ \Omega$, THD = 10%, $f = 1\ \text{kHz}$, 20 kHz BW, $V_{DD} = 3.6\text{ V}$ | | 0.94 | | W |
| | | $R_L = 4\ \Omega$, THD = 1%, $f = 1\ \text{kHz}$, 20 kHz BW, $V_{DD} = 5.0\text{ V}$ | | 2.0 | | W |
| | | $R_L = 4\ \Omega$, THD = 1%, $f = 1\ \text{kHz}$, 20 kHz BW, $V_{DD} = 3.6\text{ V}$ | | 1.3 | | W |
| | | $R_L = 4\ \Omega$, THD = 10%, $f = 1\ \text{kHz}$, 20 kHz BW, $V_{DD} = 5.0\text{ V}$ | | 2.5 ¹ | | W |
| | | $R_L = 4\ \Omega$, THD = 10%, $f = 1\ \text{kHz}$, 20 kHz BW, $V_{DD} = 3.6\text{ V}$ | | 1.7 | | W |
| Efficiency | η | $P_O = 1.4\text{ W}$, $8\ \Omega$, $V_{DD} = 5.0\text{ V}$, EDGE = GND (normal, low EMI mode) | | 92 | | % |
| | | $P_O = 1.4\text{ W}$, $8\ \Omega$, $V_{DD} = 5.0\text{ V}$, EDGE = V_{DD} (ultralow EMI mode) | | 90 | | % |
| Total Harmonic Distortion + Noise | THD + N | $P_O = 1\text{ W}$ into $8\ \Omega$, $f = 1\ \text{kHz}$, $V_{DD} = 5.0\text{ V}$ | | 0.004 | | % |
| | | $P_O = 0.5\text{ W}$ into $8\ \Omega$, $f = 1\ \text{kHz}$, $V_{DD} = 3.6\text{ V}$ | | 0.004 | | % |
| Input Common-Mode Voltage Range | V_{CM} | | 1.0 | | $V_{DD} - 1$ | V |
| Common-Mode Rejection Ratio | CMRR _{GSM} | $V_{CM} = 2.5\text{ V} \pm 100\text{ mV}$ at 217 Hz, output referred | | 55 | | dB |
| Channel Separation | X_{TALK} | $P_O = 100\text{ mW}$, $f = 1\ \text{kHz}$ | | 78 | | dB |
| Average Switching Frequency | f_{SW} | | | 300 | | kHz |
| Differential Output Offset Voltage | V_{OOS} | Gain = 6 dB | | 2.0 | | mV |
| POWER SUPPLY | | | | | | |
| Supply Voltage Range | V_{DD} | Guaranteed from PSRR test | 2.5 | | 5.5 | V |
| Power Supply Rejection Ratio | PSRR (DC) | $V_{DD} = 2.5\text{ V}$ to 5.0 V , dc input floating | 70 | 85 | | dB |
| | PSRR _{GSM} | $V_{RIPPLE} = 100\text{ mV}$ at 217 Hz, inputs ac GND, $C_{IN} = 0.1\ \mu\text{F}$ | | 60 | | dB |
| Supply Current (stereo) | I_{SY} | $V_{IN} = 0\text{ V}$, no load, $V_{DD} = 5.0\text{ V}$ | | 5.75 | | mA |
| | | $V_{IN} = 0\text{ V}$, no load, $V_{DD} = 3.6\text{ V}$ | | 4.9 | | mA |
| | | $V_{IN} = 0\text{ V}$, no load, $V_{DD} = 2.5\text{ V}$ | | 4.7 | | mA |
| | | $V_{IN} = 0\text{ V}$, load = $8\ \Omega + 33\ \mu\text{H}$, $V_{DD} = 5.0\text{ V}$ | | 5.5 | | mA |
| | | $V_{IN} = 0\text{ V}$, load = $8\ \Omega + 33\ \mu\text{H}$, $V_{DD} = 3.6\text{ V}$ | | 5.1 | | mA |
| | | $V_{IN} = 0\text{ V}$, load = $8\ \Omega + 33\ \mu\text{H}$, $V_{DD} = 2.5\text{ V}$ | | 4.5 | | mA |
| Shutdown Current | I_{SD} | $\overline{SDNR} = \overline{SDNL} = \text{GND}$ | | 20 | | nA |
| GAIN CONTROL | | | | | | |
| Closed-Loop Gain | Gain | GAIN = V_{DD} | | 18 | | dB |
| | Gain | GAIN = GND | | 6 | | dB |
| Input Impedance | Z_{IN} | $\overline{SDNR} = \overline{SDNL} = V_{DD}$; GAIN = GND or V_{DD} | | 80 | | k Ω |
| SHUTDOWN CONTROL | | | | | | |
| Input Voltage High | V_{IH} | | | 1.35 | | V |
| Input Voltage Low | V_{IL} | | | 0.35 | | V |
| Turn-On Time | t_{WU} | $\overline{SDNR}/\overline{SDNL}$ rising edge from GND to V_{DD} | | 7 | | ms |
| Turn-Off Time | t_{SD} | $\overline{SDNR}/\overline{SDNL}$ falling edge from V_{DD} to GND | | 5 | | μs |
| Output Impedance | Z_{OUT} | $\overline{SDNR}/\overline{SDNL} = \text{GND}$ | | >100 | | k Ω |
| NOISE PERFORMANCE | | | | | | |
| Output Voltage Noise | e_n | $V_{DD} = 3.6\text{ V}$, $f = 20\text{ Hz}$ to 20 kHz , inputs are ac grounded, Gain = 6 dB, A-weighted | | 29 | | μVrms |
| Signal-to-Noise Ratio | SNR | $P_O = 1.4\text{ W}$, $R_L = 8\ \Omega$ | | 100 | | dB |

¹ Note that, although the SSM2356 has good audio quality above 2 W per channel, continuous output power beyond 2 W per channel must be avoided due to device packaging limitations.

ABSOLUTE MAXIMUM RATINGS

Absolute maximum ratings apply at 25°C, unless otherwise noted.

Table 2.

| Parameter | Rating |
|---|-----------------|
| Supply Voltage | 6 V |
| Input Voltage | V _{DD} |
| Common-Mode Input Voltage | V _{DD} |
| ESD Susceptibility | 4 kV |
| Storage Temperature Range | –65°C to +150°C |
| Operating Temperature Range | –40°C to +85°C |
| Junction Temperature Range | –65°C to +165°C |
| Lead Temperature Range (Soldering, 60 sec) | 300°C |

Stresses above those listed under Absolute Maximum Ratings may cause permanent damage to the device. This is a stress rating only; functional operation of the device at these or any other conditions above those indicated in the operational section of this specification is not implied. Exposure to absolute maximum rating conditions for extended periods may affect device reliability.

THERMAL RESISTANCE

θ_{JA} (junction to air) is specified for the worst-case conditions, that is, a device soldered in a circuit board for surface-mount packages. θ_{JA} and θ_{JB} (junction to board) are determined according to JESD51-9 on a 4-layer printed circuit board (PCB) with natural convection cooling.

Table 3. Thermal Resistance

| Package Type | θ_{JA} | θ_{JB} | Unit |
|----------------------------------|---------------|---------------|------|
| 16-ball, 1.66 mm × 1.66 mm WLCSP | 66 | 19 | °C/W |

ESD CAUTION



ESD (electrostatic discharge) sensitive device. Charged devices and circuit boards can discharge without detection. Although this product features patented or proprietary protection circuitry, damage may occur on devices subjected to high energy ESD. Therefore, proper ESD precautions should be taken to avoid performance degradation or loss of functionality.

PIN CONFIGURATION AND FUNCTION DESCRIPTIONS

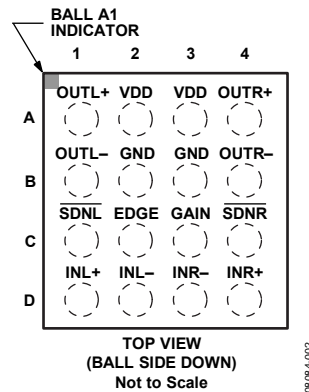

Figure 2. Pin Configuration (Top Side View)

Table 4. Pin Function Descriptions

| Bump | Mnemonic | Description |
|------|--------------------------|--|
| A1 | OUTL+ | Noninverting Output for Left Channel. |
| B1 | OUTL- | Inverting Output for Left Channel. |
| C1 | $\overline{\text{SDNL}}$ | Shutdown, Left Channel. Active low digital input. |
| D1 | INL+ | Noninverting Input for Left Channel. |
| D2 | INL- | Inverting Input for Left Channel. |
| C4 | $\overline{\text{SDNR}}$ | Shutdown, Right Channel. Active low digital input. |
| C3 | GAIN | Gain select between 6 dB and 18 dB. |
| D3 | INR- | Inverting Input for Right Channel. |
| D4 | INR+ | Noninverting Input for Right Channel. |
| B2 | GND | Ground. |
| B4 | OUTR- | Inverting Output for Right Channel. |
| A4 | OUTR+ | Noninverting Output for Right Channel. |
| B3 | GND | Ground. |
| A2 | VDD | Power Supply. |
| A3 | VDD | Power Supply. |
| C2 | EDGE | Edge Control (Low Emission Mode); active high digital input. |

TYPICAL PERFORMANCE CHARACTERISTICS

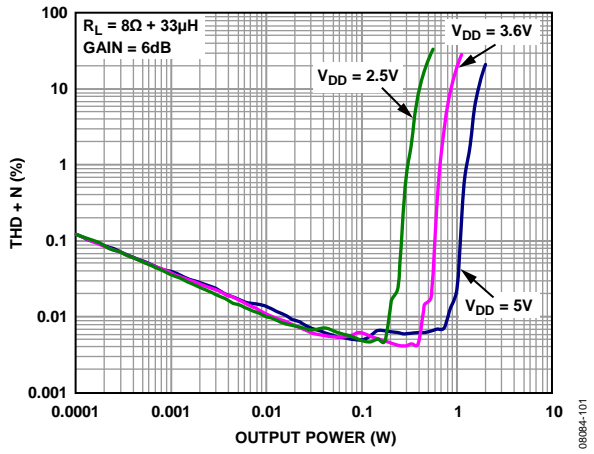

Figure 3. THD + N vs. Output Power into 8Ω, Av = 6 dB

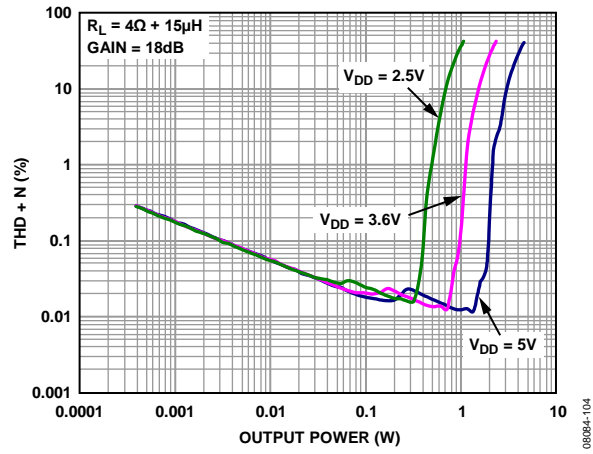

Figure 6. THD + N vs. Output Power into 4Ω, Av = 18 dB

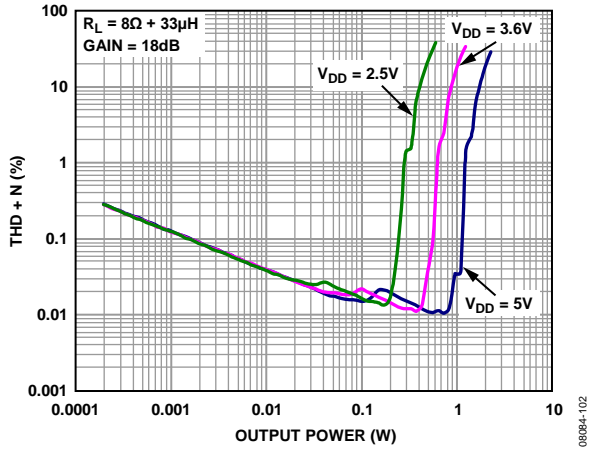

Figure 4. THD + N vs. Output Power into 8Ω, Av = 18 dB

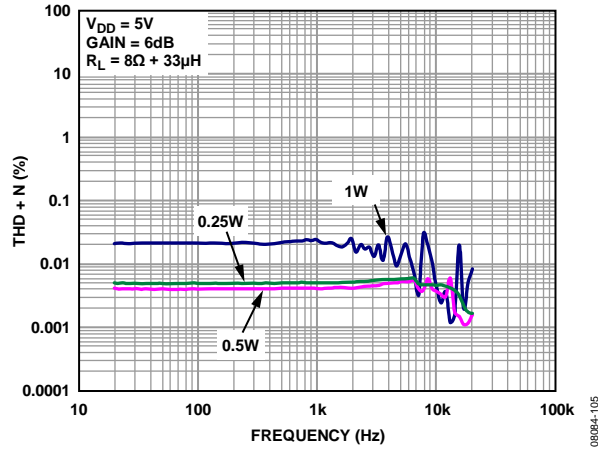

Figure 7. THD + N vs. Frequency, VDD = 5 V, RL = 8Ω, Av = 6 dB

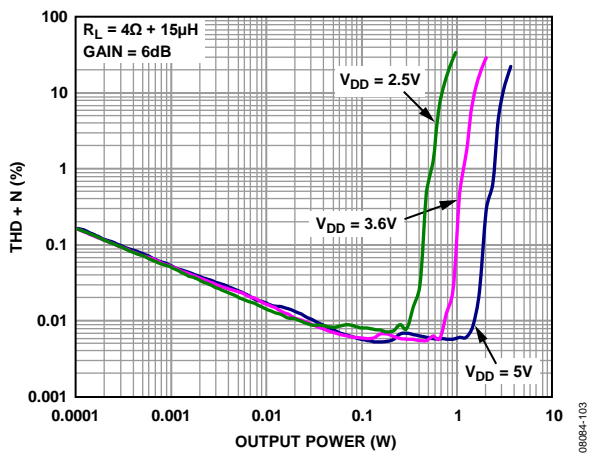

Figure 5. THD + N vs. Output Power into 4Ω, Av = 6 dB

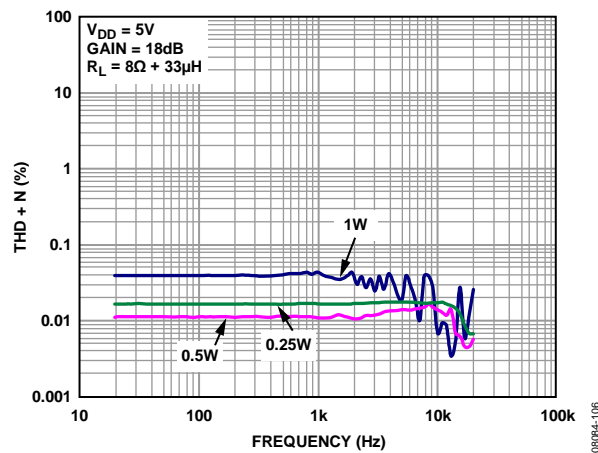

Figure 8. THD + N vs. Frequency, VDD = 5 V, RL = 8Ω, Av = 18 dB

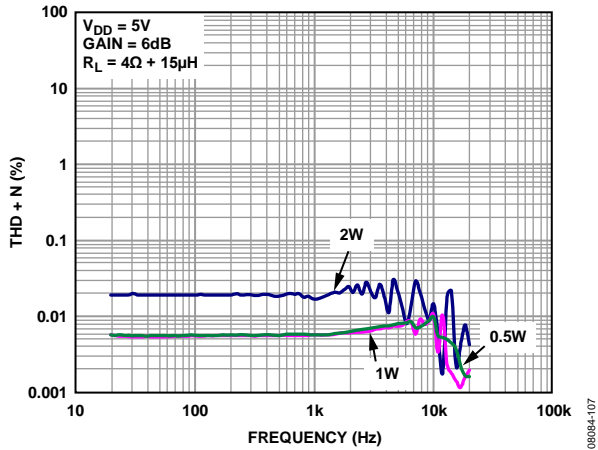

Figure 9. THD + N vs. Frequency, $V_{DD} = 5\text{ V}$, $R_L = 4\ \Omega$, $A_v = 6\text{ dB}$

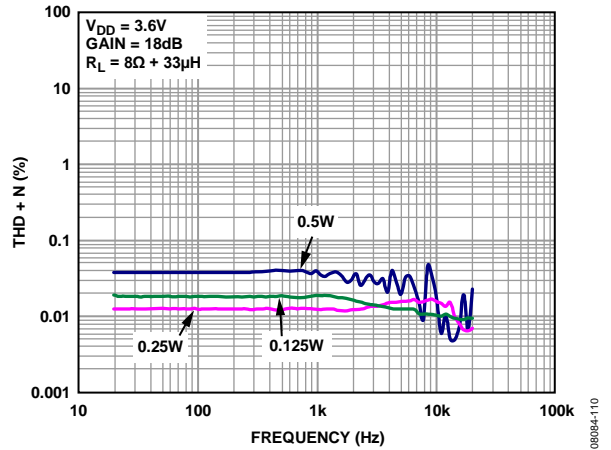

Figure 12. THD + N vs. Frequency, $V_{DD} = 3.6\text{ V}$, $R_L = 8\ \Omega$, $A_v = 18\text{ dB}$

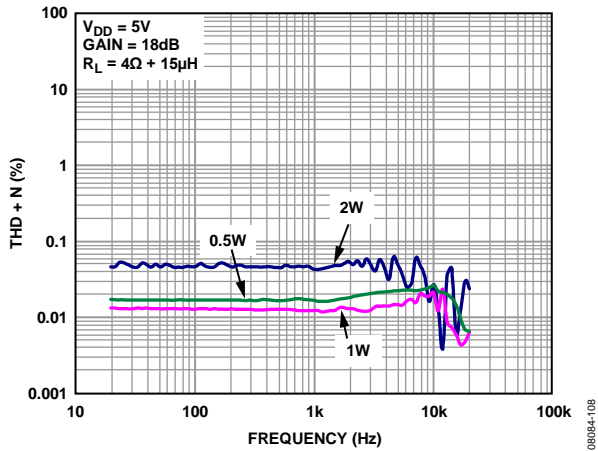

Figure 10. THD + N vs. Frequency, $V_{DD} = 5\text{ V}$, $R_L = 8\ \Omega$, $A_v = 18\text{ dB}$

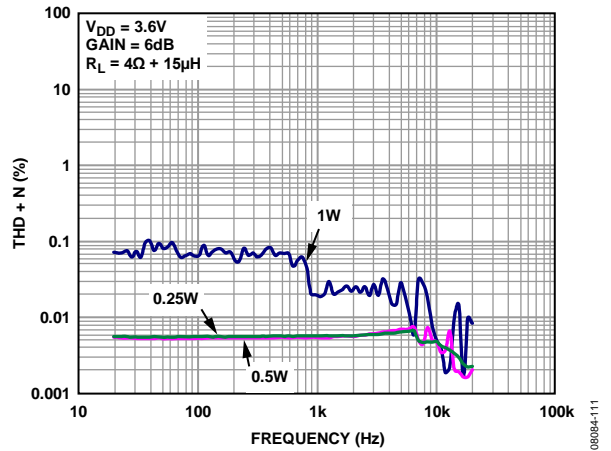

Figure 13. THD + N vs. Frequency, $V_{DD} = 3.6\text{ V}$, $R_L = 4\ \Omega$, $A_v = 6\text{ dB}$

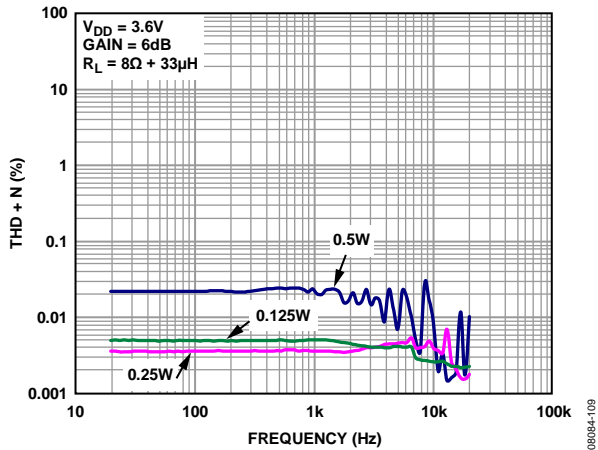

Figure 11. THD + N vs. Frequency, $V_{DD} = 3.6\text{ V}$, $R_L = 8\ \Omega$, $A_v = 6\text{ dB}$

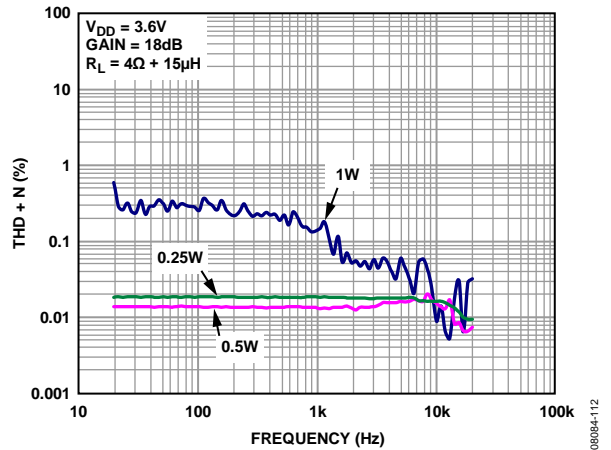

Figure 14. THD + N vs. Frequency, $V_{DD} = 3.6\text{ V}$, $R_L = 4\ \Omega$, $A_v = 18\text{ dB}$

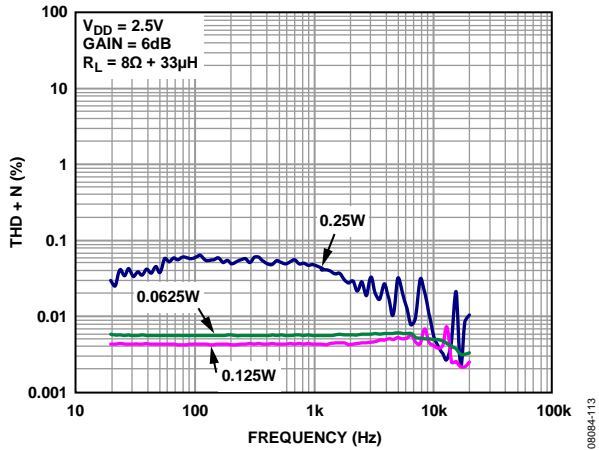

Figure 15. THD + N vs. Frequency, $V_{DD} = 2.5\text{ V}$, $R_L = 8\ \Omega$, $A_v = 6\text{ dB}$

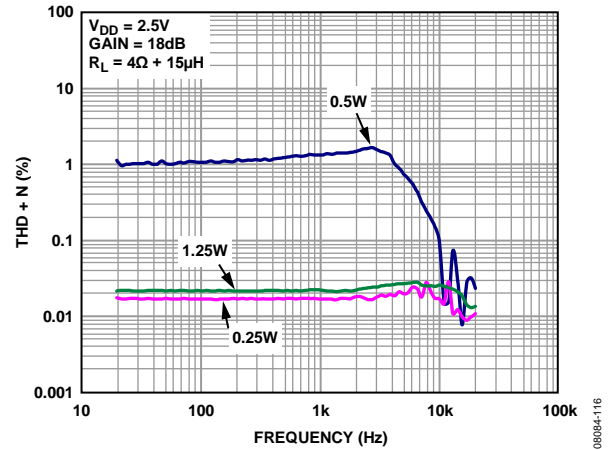

Figure 18. THD + N vs. Frequency, $V_{DD} = 2.5\text{ V}$, $R_L = 4\ \Omega$, $A_v = 18\text{ dB}$

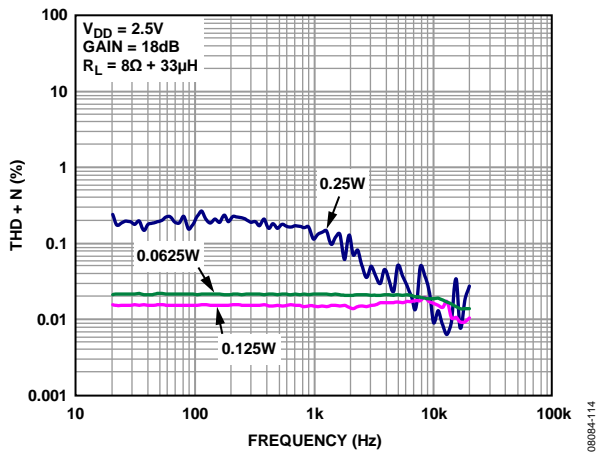

Figure 16. THD + N vs. Frequency, $V_{DD} = 2.5\text{ V}$, $R_L = 8\ \Omega$, $A_v = 18\text{ dB}$

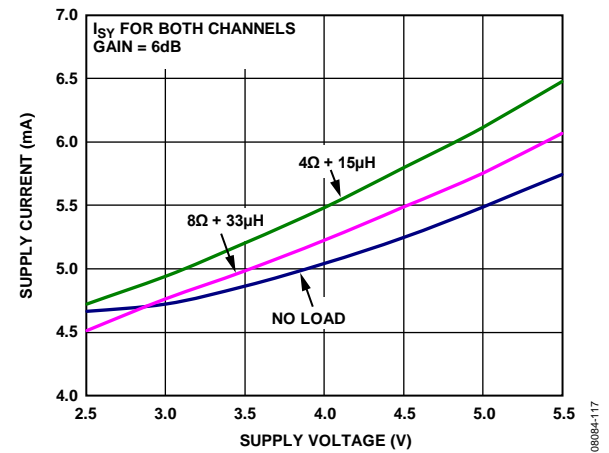

Figure 19. Supply Current vs. Supply Voltage, $A_v = 6\text{ dB}$

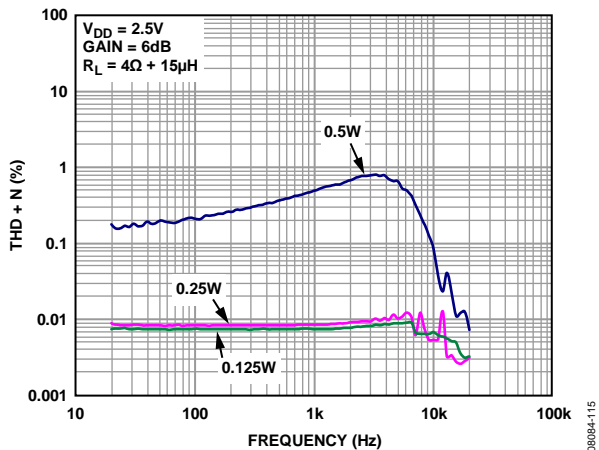

Figure 17. THD + N vs. Frequency, $V_{DD} = 2.5\text{ V}$, $R_L = 4\ \Omega$, $A_v = 6\text{ dB}$

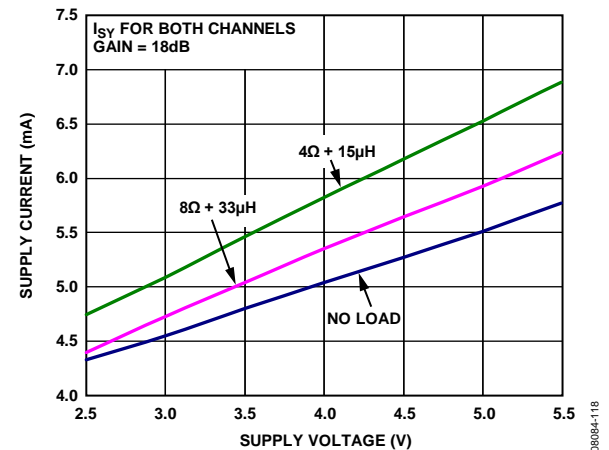

Figure 20. Supply Current vs. Supply Voltage, $A_v = 18\text{ dB}$

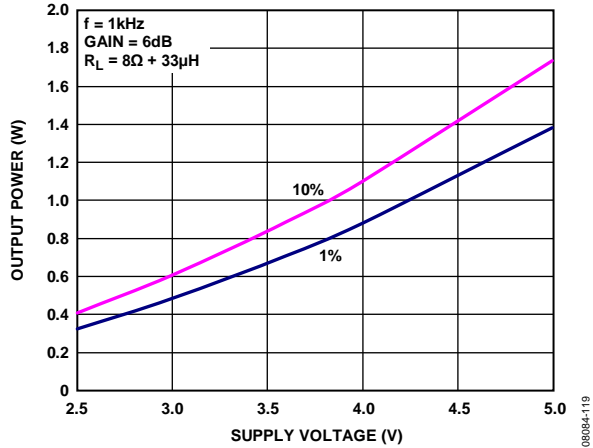

Figure 21. Maximum Output Power vs. Supply Voltage, $R_L = 8\Omega$, $A_v = 6\text{ dB}$

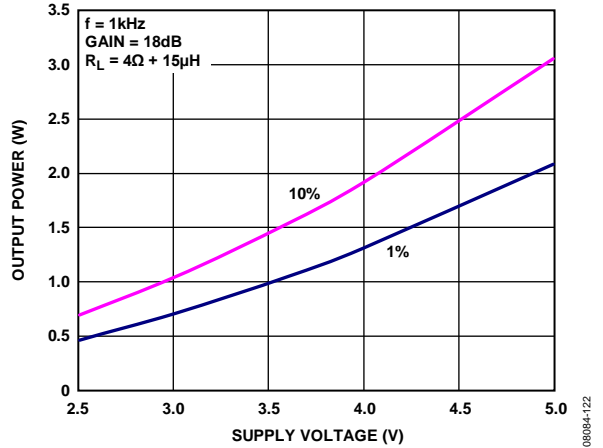

Figure 24. Maximum Output Power vs. Supply Voltage, $R_L = 4\Omega$, $A_v = 18\text{ dB}$

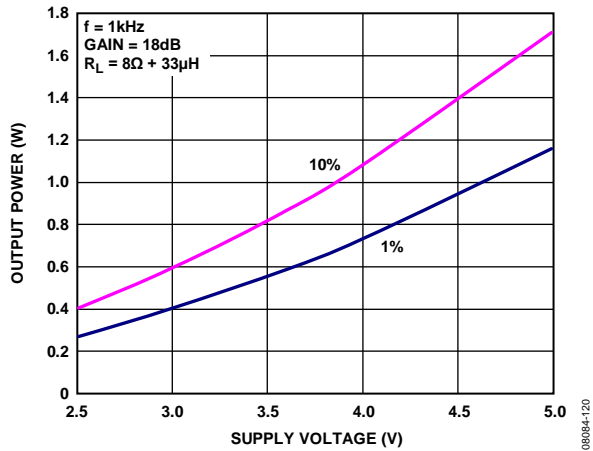

Figure 22. Maximum Output Power vs. Supply Voltage, $R_L = 8\Omega$, $A_v = 18\text{ dB}$

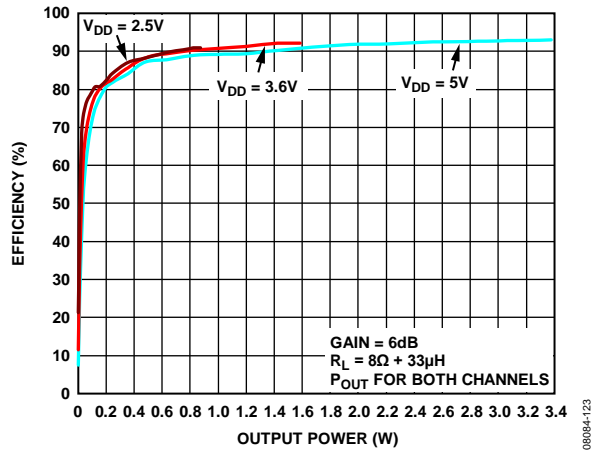

Figure 25. Efficiency vs. Output Power into 8Ω

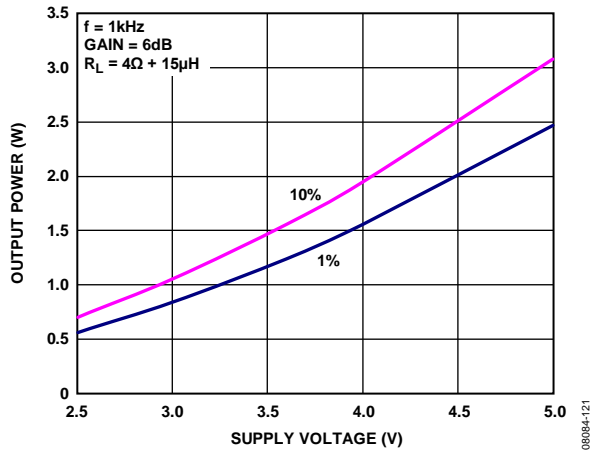

Figure 23. Maximum Output Power vs. Supply Voltage, $R_L = 4\Omega$, $A_v = 6\text{ dB}$

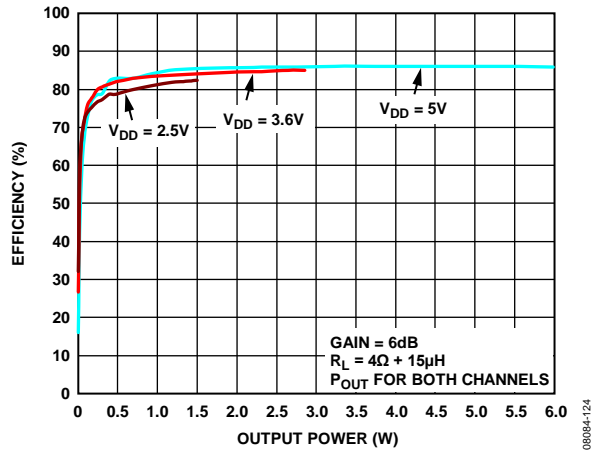

Figure 26. Efficiency vs. Output Power into 4Ω

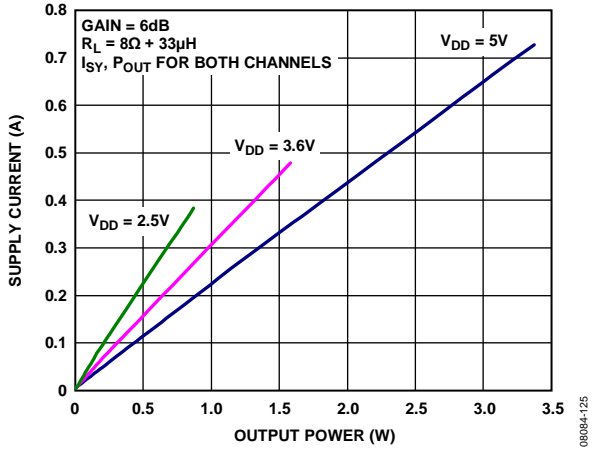

Figure 27. Supply Current vs. Output Power into 8 Ω

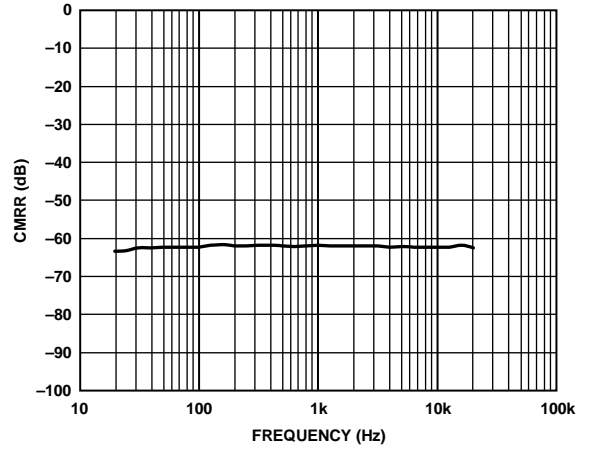

Figure 30. CMRR vs. Frequency

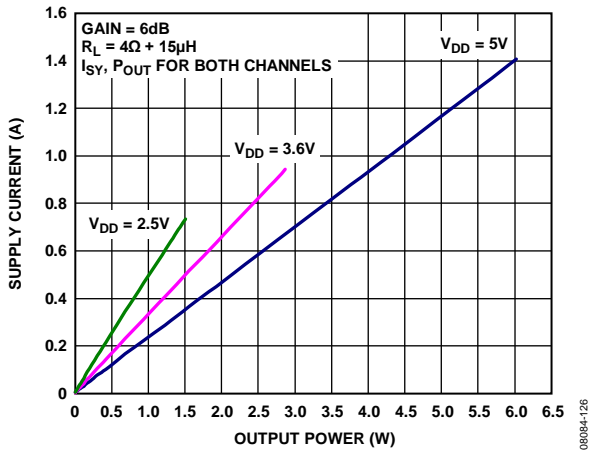

Figure 28. Supply Current vs. Output Power into 4 Ω

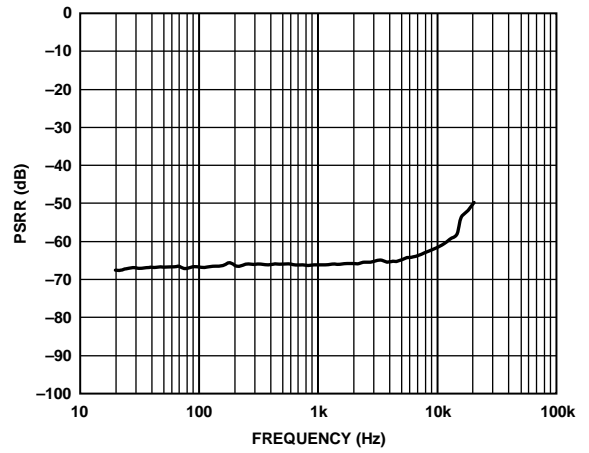

Figure 31. PSRR vs. Frequency

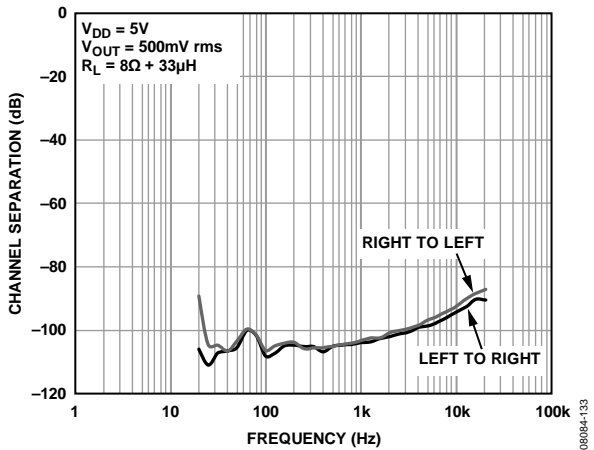

Figure 29. Crosstalk v. Frequency

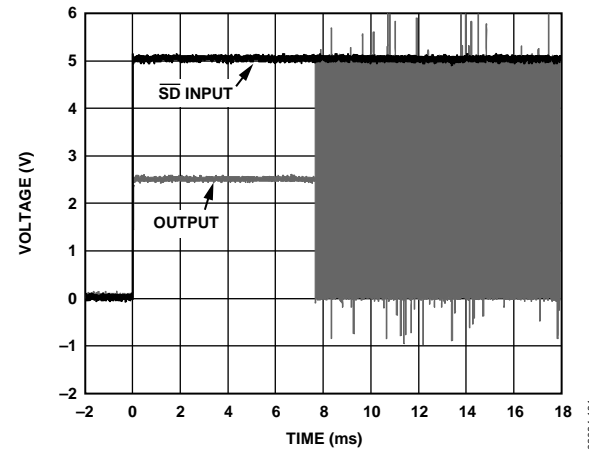

Figure 32. Turn-On Response

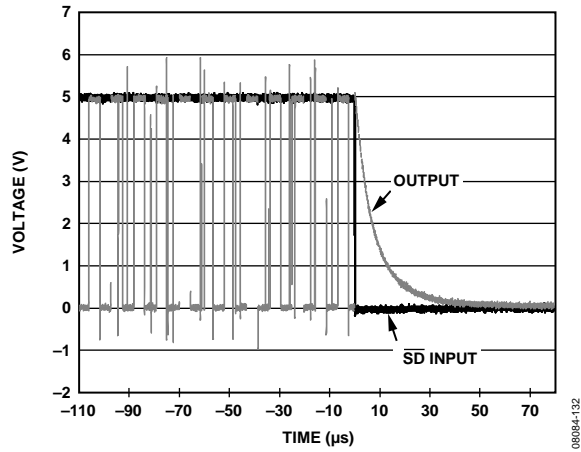

Figure 33. Turn-Off Response

TYPICAL APPLICATION CIRCUITS

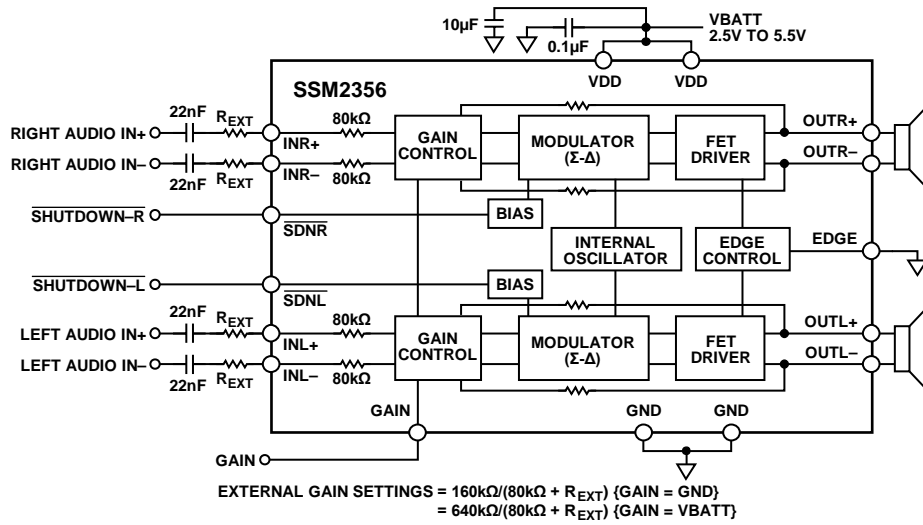

Figure 34. Stereo Differential Input Configuration
 (When GAIN = VBATT use no larger than 10 kΩ R_{EXT})

086984-003

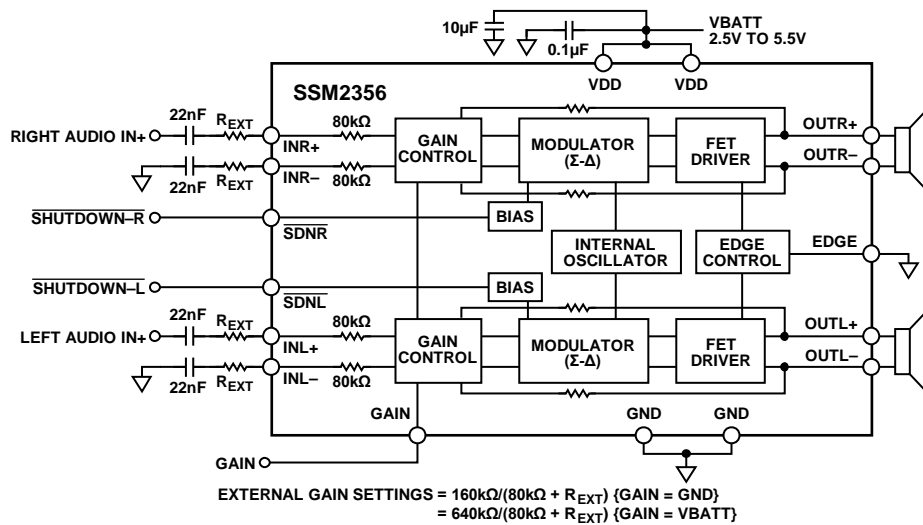

Figure 35. Stereo Single-Ended Input Configuration
 (When GAIN = VBATT use no larger than 10 kΩ R_{EXT})

086984-004

APPLICATIONS INFORMATION

OVERVIEW

The SSM2356 stereo Class-D audio amplifier features a filterless modulation scheme that greatly reduces the external component count, conserving board space and, thus, reducing systems cost. The SSM2356 does not require an output filter but, instead, relies on the inherent inductance of the speaker coil and the natural filtering of the speaker and human ear to fully recover the audio component of the square wave output. Most Class-D amplifiers use some variation of pulse-width modulation (PWM), but the SSM2356 uses Σ - Δ modulation to determine the switching pattern of the output devices, resulting in a number of important benefits. Σ - Δ modulators do not produce a sharp peak with many harmonics in the AM frequency band, as pulse-width modulators often do. Σ - Δ modulation provides the benefits of reducing the amplitude of spectral components at high frequencies, that is, reducing EMI emission that might otherwise be radiated by speakers and long cable traces. Due to the inherent spread-spectrum nature of Σ - Δ modulation, the need for oscillator synchronization is eliminated for designs incorporating multiple SSM2356 amplifiers.

The SSM2356 also integrates overcurrent and temperature protection.

GAIN SELECTION

The preset gain of SSM2356 can be selected between 6 dB and 18 dB with no external components and no change to the input impedance. A major benefit of fixed input impedance is that there is no need to recalculate input corner frequency (F_c) when gain is adjusted. The same input coupling components can be used for both gain settings.

It is possible to adjust the SSM2356 gain by using external resistors at the input. To set a gain lower than 18 dB (or 6 dB when $GAIN = GND$), refer to Figure 34 for the differential input configuration and Figure 35 for the single-ended configuration. Calculate the external gain configuration as follows:

When $GAIN = GND$ (6 dB default gain setting)

$$\text{External Gain Settings} = 160 \text{ k}\Omega / (80 \text{ k}\Omega + R_{EXT})$$

When $GAIN = V_{DD}$ (18 dB default gain setting)

$$\text{External Gain Settings} = 640 \text{ k}\Omega / (80 \text{ k}\Omega + R_{EXT})$$

Please note that when using external resistors to adjust the gain from the 18 dB setting ($GAIN = V_{DD}$) to maintain optimal audio performance, it is not recommended to use external series resistors larger than 10 k Ω due to increased noise floor and reduced THD+N performance.

POP-AND-CLICK SUPPRESSION

Voltage transients at the output of audio amplifiers may occur when shutdown is activated or deactivated. Voltage transients as low as 10 mV can be heard as an audio pop in the speaker. Clicks and pops can also be classified as undesirable audible transients generated by the amplifier system and, therefore, as not coming from the system input signal.

Such transients may be generated when the amplifier system changes its operating mode. For example, the following can be sources of audible transients:

- System power-up/power-down
- Mute/unmute
- Input source change
- Sample rate change

The SSM2356 has a pop-and-click suppression architecture that reduces these output transients, resulting in noiseless activation and deactivation.

EMI NOISE

The SSM2356 uses a proprietary modulation and spread-spectrum technology to minimize EMI emissions from the device. For applications having difficulty passing FCC Class B emission tests, the SSM2356 includes a modulation select pin (ultralow EMI emission mode) that significantly reduces the radiated emissions at the Class-D outputs, particularly above 100 MHz. Figure 36 shows SSM2356 EMI emission tests performed in a certified FCC Class-B laboratory in normal emissions mode ($EDGE = GND$). Figure 37 shows SSM2356 EMI emission with $EDGE = V_{DD}$, placing the device in low emissions mode.

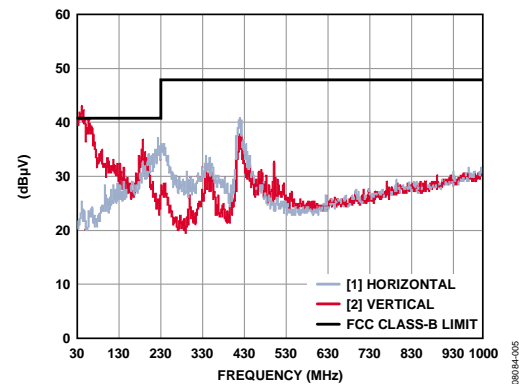

Figure 36. EMI Emissions from SSM2356, 1-Channel, 12 cm Cable, $EDGE = GND$

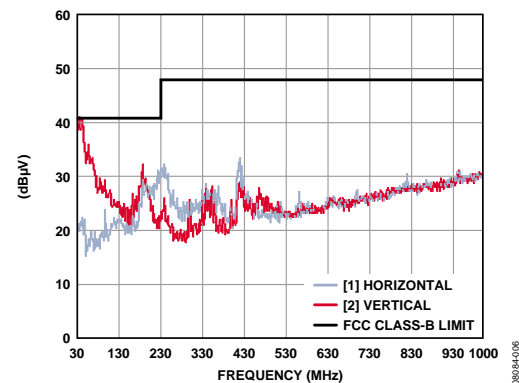

Figure 37. EMI Emissions from SSM2356, 1-Channel, 12 cm Cable, $EDGE = V_{DD}$

The measurements for Figure 36 and Figure 37 were taken in an FCC-certified EMI laboratory with a 1 kHz input signal, producing 0.5 W output power into an 8 Ω load from a 5 V supply. Cable length was 12 cm, unshielded twisted pair speaker cable. Note that reducing the supply voltage greatly reduces radiated emissions.

OUTPUT MODULATION DESCRIPTION

The SSM2356 uses three-level, Σ - Δ output modulation. Each output can swing from GND to V_{DD} and vice versa. Ideally, when no input signal is present, the output differential voltage is 0 V because there is no need to generate a pulse. In a real-world situation, there are always noise sources present.

Due to this constant presence of noise, a differential pulse is generated, when required, in response to this stimulus. A small amount of current flows into the inductive load when the differential pulse is generated. However, most of the time, output differential voltage is 0 V, due to the Analog Devices three-level, Σ - Δ output modulation. This feature ensures that the current flowing through the inductive load is small.

When the user wants to send an input signal, an output pulse is generated to follow input voltage. The differential pulse density is increased by raising the input signal level. Figure 38 depicts three-level, Σ - Δ output modulation with and without input stimulus.

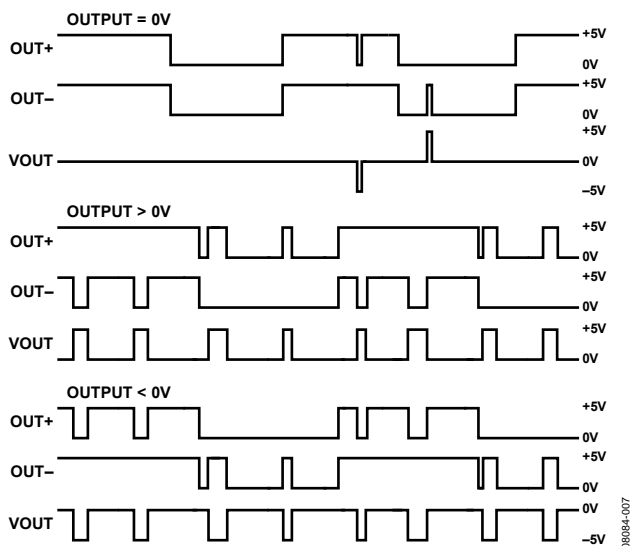

Figure 38. Three-Level, Σ - Δ Output Modulation With and Without Input Stimulus

LAYOUT

As output power continues to increase, care must be taken to lay out PCB traces and wires properly among the amplifier, load, and power supply. A good practice is to use short, wide PCB tracks to decrease voltage drops and minimize inductance. Ensure that track widths are at least 200 mil for every inch of track length for the lowest dc resistance (DCR), and use 1 oz. or 2 oz. copper PCB traces to further reduce IR drops and inductance. A poor layout increases voltage drops, consequently

affecting efficiency. Use large traces for the power supply inputs and amplifier outputs to minimize losses due to parasitic trace resistance. Proper grounding guidelines help to improve audio performance, minimize crosstalk between channels, and prevent switching noise from coupling into the audio signal.

To maintain high output swing and high peak output power, the PCB traces that connect the output pins to the load and supply pins should be as wide as possible to maintain the minimum trace resistances. It is also recommended that a large ground plane be used for minimum impedances. In addition, good PCB layout isolates critical analog paths from sources of high interference. High frequency circuits (analog and digital) should be separated from low frequency circuits.

Properly designed multilayer PCBs can reduce EMI emission and increase immunity to the RF field by a factor of 10 or more, compared with double-sided boards. A multilayer board allows a complete layer to be used for the ground plane, whereas the ground plane side of a double-sided board is often disrupted by signal crossover.

If the system has separate analog and digital ground and power planes, the analog ground plane should be directly beneath the analog power plane, and, similarly, the digital ground plane should be directly beneath the digital power plane. There should be no overlap between analog and digital ground planes or between analog and digital power planes.

INPUT CAPACITOR SELECTION

The SSM2356 does not require input coupling capacitors if the input signal is biased from 1.0 V to $V_{DD} - 1.0$ V. Input capacitors are required if the input signal is not biased within this recommended input dc common-mode voltage range, if high-pass filtering is needed, or if a single-ended source is used. If high-pass filtering is needed at the input, the input capacitor and the input resistor of the SSM2356 form a high-pass filter whose corner frequency is determined by the following equation:

$$f_c = 1/(2\pi \times R_{IN} \times C_{IN})$$

The input capacitor can significantly affect the performance of the circuit. Not using input capacitors degrades both the output offset of the amplifier and the dc PSRR performance.

PROPER POWER SUPPLY DECOUPLING

To ensure high efficiency, low total harmonic distortion (THD), and high PSRR, proper power supply decoupling is necessary. Noise transients on the power supply lines are short-duration voltage spikes. These spikes can contain frequency components that extend into the hundreds of megahertz. The power supply input must be decoupled with a good quality, low ESL, low ESR capacitor, greater than 4.7 μ F. This capacitor bypasses low frequency noises to the ground plane. For high frequency transient noises, use a 0.1 μ F capacitor as close as possible to the VDD pin of the device. Placing the decoupling capacitor as close as possible to the SSM2356 helps to maintain efficient performance.

OUTLINE DIMENSIONS

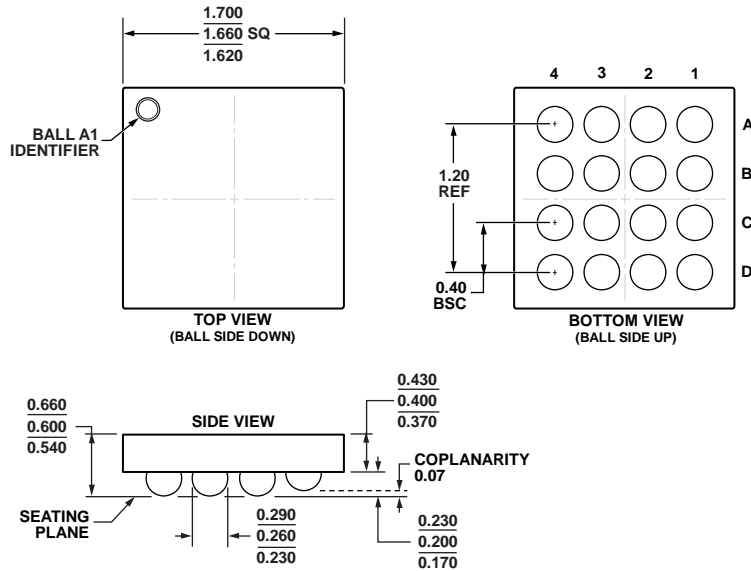

10-19-2012-B

Figure 4. 16-Ball Wafer Level Chip Scale Package [WLCSP]
(CB-16-4)
Dimensions shown in millimeters

ORDERING GUIDE

| Model ¹ | Temperature Range | Package Description | Package Option | Branding |
|--------------------|-------------------|--|----------------|----------|
| SSM2356CBZ-RL | -40°C to +85°C | 16-Ball Wafer Level Chip Scale Package [WLCSP] | CB-16-4 | Y1R |
| SSM2356CBZ-RL7 | -40°C to +85°C | 16-Ball Wafer Level Chip Scale Package [WLCSP] | CB-16-4 | Y1R |
| EVAL-SSM2356Z | | Evaluation Board | | |

¹ Z = RoHS Compliant Part.

NOTES